

READ ALL INSTRUCTIONS COMPLETELY AND THOROUGHLY UNDERSTAND THEM BEFORE DOING ANYTHING.
CALL CHASSISWORKS TECH SUPPORT (916) 388-0288 IF YOU NEED ASSISTANCE.

INSTALLATION GUIDE



5814-Q10

Billet g-Link Canted 4-Bar Air-Spring Rear Suspension 1960-1965 Falcon and Comet

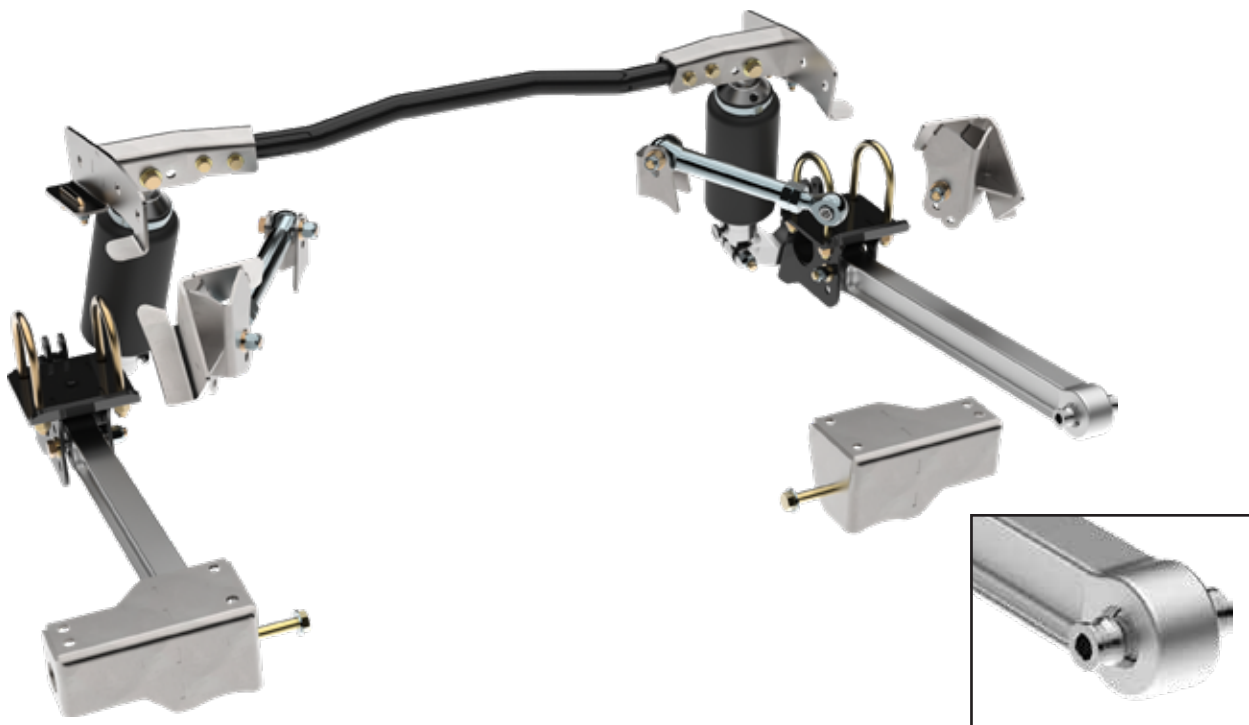

Description: Canted 4-bar air-spring rear suspension for 1960-1965 Falcon and Comet.

Includes: Upper and lower suspension links, weld-on chassis brackets, upper and lower axle brackets, shocks and springs

Note: Installation requires welding

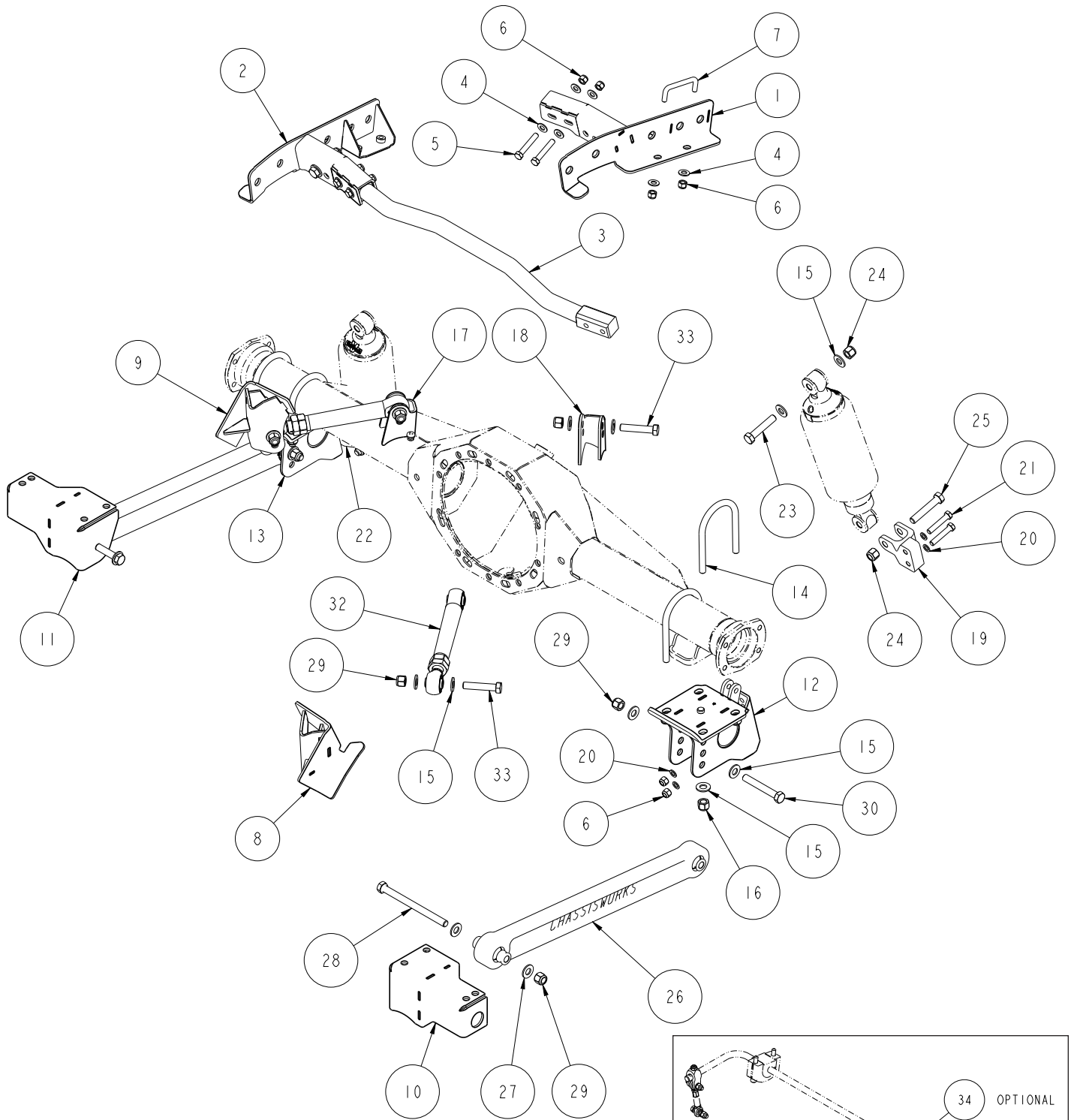

BOLT-ON AXLE BRACKETS WITH FRAME MOUNT SLIDING LINK ARB

DESCRIPTION	REAR SUSPENSION, AIRLINK BILLET, 1960-65 FALCON, COMET, RANCHERO	
	Chris Alston's CHASSISWORKS INC. 8661 YOUNGER CREEK DRIVE SACRAMENTO, CA 95828 (916) 388-0288 FAX 388-0295	PART NO. 5814-Q10
	11/3/22	DWG: 915814-010

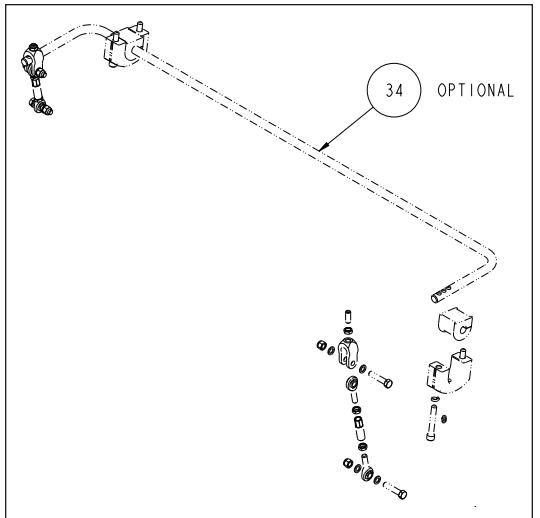

ITEM	QTY	PART NO.	DESCRIPTION
1	1	7959-0334	FRAME BRACKET WELDMENT, REAR ARB, DRIVER, 1960-65 FORD FALCON
2	1	7959-0339	FRAME BRACKET WELDMENT, REAR ARB, PASSENGER, 1960-65 FORD FALCON
3	1	7959-0356	CROSS TUBE WELDMENT, G-BAR, 1960-65 FORD FALCON
4	12	3120-038S-Y	FLAT WASHER, 3/8 SAE, HARDENED, YELLOW ZINC
5	4	3100-038F2.25Y	HEX BOLT, 3/8-24 x 2 1/4, GRADE 8, YELLOW ZINC
6	12	3101-038-24C	LOCKNUT, 3/8-24, GRADE 5, NYLON INSERT, CLEAR ZINC
7	2	3148-263.38-094	SQUARE BEND U-BOLT, 3/8-24 x 2.625 x .938
8	1	7959-0348	FRAME BRACKET WELDMENT, DRIVER UCA, 1960-65 FORD FALCON
9	1	7959-0353	FRAME BRACKET WELDMENT, PASSENGER UCA, 1960-65 FORD FALCON
10	1	7959-0361	LCA MOUNT WELDMENT, DRV, 1960-65 FALCON, COMET, RANCHERO
11	1	7959-0362	LCA MOUNT WELDMENT, PSGR, 1960-65 FALCON, COMET, RANCHERO
12	1	5336	LOWER LINK MOUNT, DRIVER, G-BAR REAR STYLE A-ROLL BAR, 64-70 MUSTANG
13	1	5337	LOWER LINK MOUNT, PSGR, G-BAR REAR STYLE A-ROLL BAR, 64-70 MUSTANG
14	4	3147-300.50-500	U-BOLT, AXLE TUBE, 1/2-20 x 3.00 x 5.00
15	24	3120-050S-Y	FLAT WASHER, 1/2 SAE, HARDENED, YELLOW ZINC
16	8	3131-050-20Y	LOCKNUT 1/2-20, GRADE 8, NYLON INSERT, YELLOW ZINC
17	1	230229	UCA AXLE BRACKET, DRIVER G-BAR, 64-70 MUSTANG
18	1	230230	UCA AXLE BRACKET, PSGR G-BAR, 64-70 MUSTANG
19	1	1477-D	G-BAR STRAIGHT SHOCK MOUNT, DRIVER, ADJUSTABLE, OFFSET
20	8	3109-038-S-2-Y	AIRCRAFT WASHER 3/8 x .062 THICK
21	4	3100-038F2.00Y	HEX BOLT, 3/8-24 x 2, GRADE 8, YELLOW ZINC
22	1	1477-P	G-BAR STRAIGHT SHOCK MOUNT, PSGR, ADJUSTABLE, OFFSET
23	2	3100-050F2.50Y	HEX BOLT, 1/2-20 x 2 1/2, GRADE 8, YELLOW ZINC
24	4	3101-050-20C	LOCKNUT, 1/2-20, GRADE 5, NYLON INSERT, CLEAR ZINC
25	2	3100-050F2.75Y	HEX BOLT, 1/2-20 x 2 3/4, GRADE 8, YELLOW ZINC
26	1	3811-21.00-ADD	LOWER CONTROL ARM ASSEMBLY, DRIVER, G-BAR, 21 LONG, BILLET 4-LINK
27	4	3157-050S-C	WASHER, 1/2 SAE, ZINC PLATED, 1/2 ID x 1 1/16 OD x 3/32 THICK
28	2	3100-050C6.50Y	HEX BOLT, 1/2-13 x 6 1/2, GRADE 8, YELLOW ZINC
29	8	3101-050-13C	LOCKNUT 1/2-13, GRADE 5, NYLON INSERT, CLEAR ZINC
30	2	3100-050C3.50Y	HEX BOLT, 1/2-13 x 3 1/2, GRADE 8, YELLOW ZINC
31	1	3811-21.00-ADP	LOWER CONTROL ARM ASSEMBLY, PSGR, G-BAR, 21 LONG, BILLET 4-LINK
32	2	3814-09.50	G-LINK UPPER LINK ASSY, SA, BALL PIVOT, 9.50 CENTER LENGTH
33	4	3100-050C2.50Y	HEX BOLT, 1/2-13 x 2 1/2, GRADE 8, YELLOW ZINC
34	1	5812-Q10	ANTI-ROLL BAR, 5/8 OD, ADJUSTABLE LINK, 1960-65 FORD FALCON, G-BAR

BOLT-ON AXLE BRACKETS WITH FRAME MOUNT SLIDING LINK ARB

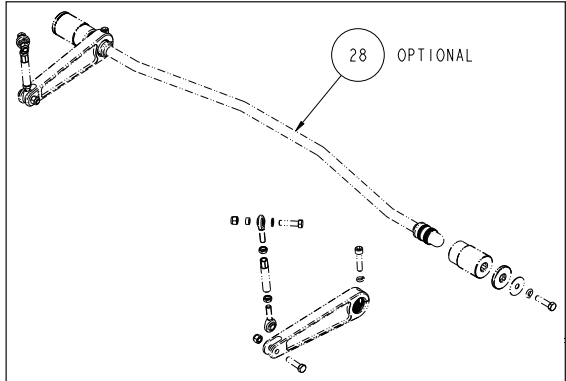
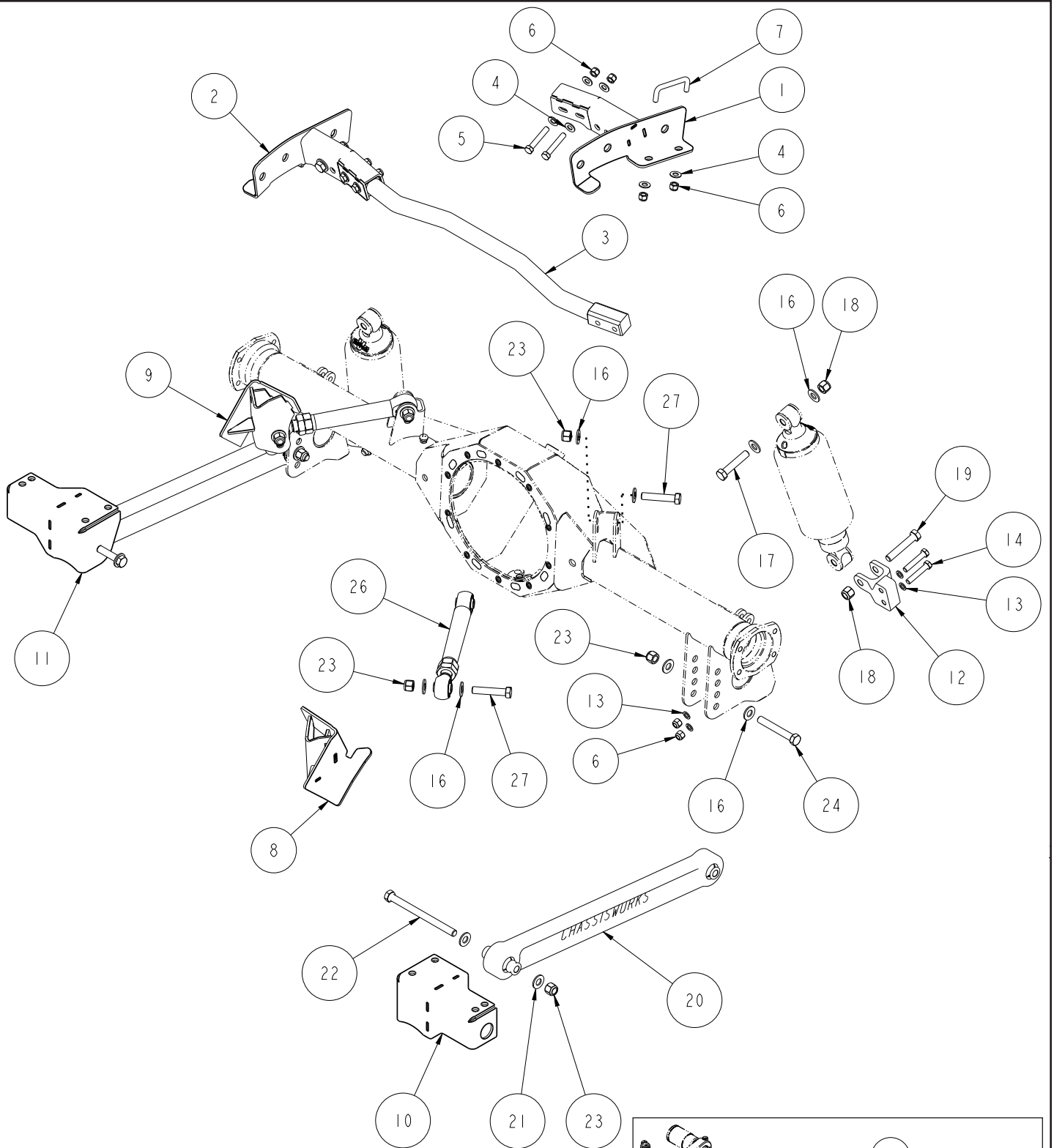

FAB9 WITH AXLE MOUNT SPLINED ARB

DESCRIPTION	REAR SUSPENSION, AIRLINK BILLET, 1960-65 FALCON, COMET, RANCHERO	
	Chris Alston's CHASSISWORKS INC. 8661 YOUNGER CREEK DRIVE SACRAMENTO, CA 95828 (916) 388-0288 FAX 388-0295	PART NO. 5814-Q10
	11/3/22	DWG: 915814-Q10

ITEM	QTY	PART NO.	DESCRIPTION
1	1	7959-0344	FRAME BRACKET WELDMENT, AXLE ARB, DRIVER, 1960-65 FORD FALCON
2	1	7959-0346	FRAME BRACKET WELDMENT, AXLE ARB, PASSENGER, 1960-65 FORD FALCON
3	1	7959-0356	CROSS TUBE WELDMENT, G-BAR, 1960-65 FORD FALCON
4	12	3120-038S-Y	FLAT WASHER, 3/8 SAE, HARDENED, YELLOW ZINC
5	4	3100-038F2.25Y	HEX BOLT, 3/8-24 x 2 1/4, GRADE 8, YELLOW ZINC
6	12	3101-038-24C	LOCKNUT, 3/8-24, GRADE 5, NYLON INSERT, CLEAR ZINC
7	2	3148-263.38-094	SQUARE BEND U-BOLT, 3/8-24 x 2.625 x .938
8	1	7959-0348	FRAME BRACKET WELDMENT, DRIVER UCA, 1960-65 FORD FALCON
9	1	7959-0353	FRAME BRACKET WELDMENT, PASSENGER UCA, 1960-65 FORD FALCON
10	1	7959-0361	LCA MOUNT WELDMENT, DRV, 1960-65 FALCON, COMET, RANCHERO
11	1	7959-0362	LCA MOUNT WELDMENT, PSGR, 1960-65 FALCON, COMET, RANCHERO
12	1	1477-D	G-BAR STRAIGHT SHOCK MOUNT, DRIVER, ADJUSTABLE, OFFSET
13	8	3109-038-S-2-Y	AIRCRAFT WASHER 3/8 x .062 THICK
14	4	3100-038F2.00Y	HEX BOLT, 3/8-24 x 2, GRADE 8, YELLOW ZINC
15	1	1477-P	G-BAR STRAIGHT SHOCK MOUNT, PSGR, ADJUSTABLE, OFFSET
16	16	3120-050S-Y	FLAT WASHER, 1/2 SAE, HARDENED, YELLOW ZINC
17	2	3100-050F2.50Y	HEX BOLT, 1/2-20 x 2 1/2, GRADE 8, YELLOW ZINC
18	4	3101-050-20C	LOCKNUT, 1/2-20, GRADE 5, NYLON INSERT, CLEAR ZINC
19	2	3100-050F2.75Y	HEX BOLT, 1/2-20 x 2 3/4, GRADE 8, YELLOW ZINC
20	1	3811-21.00-ADD	LOWER CONTROL ARM ASSEMBLY, DRIVER, G-BAR, 21 LONG, BILLET 4-LINK
21	4	3157-050S-C	WASHER, 1/2 SAE, ZINC PLATED, 1/2 ID x 1 1/16 OD x 3/32 THICK
22	2	3100-050C6.50Y	HEX BOLT, 1/2-13 x 6 1/2, GRADE 8, YELLOW ZINC
23	8	3101-050-13C	LOCKNUT 1/2-13, GRADE 5, NYLON INSERT, CLEAR ZINC
24	2	3100-050C3.50Y	HEX BOLT, 1/2-13 x 3 1/2, GRADE 8, YELLOW ZINC
25	1	3811-21.00-ADP	LOWER CONTROL ARM ASSEMBLY, PSGR, G-BAR, 21 LONG, BILLET 4-LINK
26	2	3814-09.50	G-LINK UPPER LINK ASSY, SA, BALL PIVOT, 9.50 CENTER LENGTH
27	4	3100-050C2.50Y	HEX BOLT, 1/2-13 x 2 1/2, GRADE 8, YELLOW ZINC
28	1	5806-Q10	ANTI-ROLL BAR, SPLINED, 1960-65 FORD FALCON, G-BAR

FAB9 WITH AXLE MOUNT SPLINED ARB

PARTS LIST

Use the following parts lists to verify that you have received all components required for installation.

7959-0356 - Shock Crossmember

Qty	Part Number	Description
1	7959-0356	Shock mount crossmember weldment

Shock Crossmember Frame Mounts (OPTIONS)

(You will receive one of the two component groups listed.)

300-0218 - Frame Mounts for Splined-End or omitted Anti-Roll Bar

Qty	Part Number	Description
1	7959-0344	Shock crossmember mount, driver side
1	7959-0346	Shock crossmember mount, passenger side
90300-0218 - Hardware Bag		
4	3100-038F2.25Y	Bolt, 3/8-24 x 2-1/4" hex head, Grade 8
2	3100-050F2.50Y	Bolt, 1/2-20 x 2-1/2" hex head, Grade 8
8	3101-038-24C	Locknut, 3/8-24 nylon insert
2	3101-050-20C	Locknut, 1/2-20 nylon insert
12	3120-038S-Y	Washer, 3/8" hardened flat SAE
4	3120-050S-Y	Washer, 1/2" hardened flat SAE
2	3148-263.38-094	U-bolt, square 3/8-24 x 2-5/8" wide x 15/16" long

300-0217 - Frame Mounts for Sliding-Link Anti-Roll Bar

Qty	Part Number	Description
1	7959-0334	Shock crossmember and anti-roll bar mount, driver side
1	7959-0339	Shock crossmember and anti-roll bar mount, passenger side
90300-0217 - Hardware Bag		
4	3100-038F2.25Y	Bolt, 3/8-24 x 2-1/4" hex head, Grade 8
2	3100-050F2.50Y	Bolt, 1/2-20 x 2-1/2" hex head, Grade 8
8	3101-038-24C	Locknut, 3/8-24 nylon insert
2	3101-050-20C	Locknut, 1/2-20 nylon insert
12	3120-038S-Y	Washer, 3/8" hardened flat SAE
4	3120-050S-Y	Washer, 1/2" hardened flat SAE
2	3148-263.38-094	U-bolt, square 3/8-24 x 2-5/8" wide x 15/16" long

Shocks and Springs (OPTIONS)

(You will receive one of the shocks listed.)

Qty	Part Number	Description
1 (pair)	VAS 131K2-515	QuickSet 1 (single-adjustable) air-spring; poly-eye, 5.15" travel
1 (pair)	VAS 132K2-515	QuickSet 2 (double-adjustable) air-spring; poly-eye, 5.15" travel

300-0106 - Billet-Aluminum Lower Shock Mounts

Qty	Part Number	Description
1	1477-D	Billet shock mount, driver-side
1	1477-P	Billet shock mount, passenger-side
90300-0106 - Hardware Bag		
4	3100-038F2.00Y	Bolt, 3/8-24 x 2" hex head, Grade 8
2	3100-050F2.75Y	Bolt, 1/2-20 x 2-3/4" hex head, Grade 8
4	3101-038-24C	Locknut, 3/8-24 nylon insert
2	3101-050-20C	Locknut, 1/2-20 nylon insert
8	3109-038-S-2-Y	Aircraft washer, 3/8" small OD

300-0219 - Lower Control Arm Chassis Mounts

Qty	Part Number	Description
1	7959-0361	Lower arm mount, driver side
1	7959-0362	Lower arm mount, passenger side

Lower Control Arms (OPTIONS)

(You will receive one of the two component groups listed.)

300-0103 - Lower Control Arms (Centered Pivot-Ball)

Qty	Part Number	Description
1	3811-21.00-ADD	Billet g-Link centered pivot-ball lower link assembly, 21" long, driver side
1	3811-21.00-ADP	Billet g-Link centered pivot-ball lower link assembly, 21" long, passenger side
90300-0103 - Hardware Bag		
2	3100-050C3.50Y	Bolt, 1/2-13 x 3-1/2" hex head Grade 8
2	3100-050C4.75Y	Bolt, 1/2-13 x 4-3/4" hex head Grade 8 (NOT USED)
2	3100-050C6.50Y	Bolt, 1/2-13 x 6-1/2" hex head Grade 8
4	3101-050-13C	Locknut, 1/2-13 nylon insert
8	3120-050S-Y	Washer, 1/2" hardened flat SAE

300-0199 - Lower Control Arms (Offset Pivot-Ball)

Qty	Part Number	Description
1	3817-21.00-ADD	g-Link 1" offset pivot-ball lower link assembly, 21" long, driver side
1	3817-21.00-ADP	Billet g-Link 1" offset pivot-ball lower link assembly, 21" long, psgr. side
90300-0199 - Hardware Bag		
2	3100-050C3.50Y	Bolt, 1/2-13 x 3-1/2" hex head Grade 8
2	3100-050C4.75Y	Bolt, 1/2-13 x 4-3/4" hex head Grade 8 (NOT USED)
2	3100-050C6.50Y	Bolt, 1/2-13 x 6-1/2" hex head Grade 8
4	3101-050-13C	Locknut, 1/2-13 nylon insert
8	3120-050S-Y	Washer, 1/2" hardened flat SAE

300-0221 - Upper Control Arm Chassis Mounts

Qty	Part Number	Description
1	7959-0348	Upper arm mount weldment, driver side
1	7959-0353	Upper arm mount weldment, passenger side

Upper Control Arms (OPTIONS)

(You will receive one of the two component groups listed.)

300-0105 - Upper Control Arms, Single-Adjustable

Qty	Part Number	Description
2	3814-09.50	g-Link control arm, single-adjustable, 9-1/2" long
90300-0105 - Hardware Bag		
4	3100-050F2.75Y	Bolt, 1/2-20 x 2-3/4" hex head Grade 8
4	3101-050-20C	Locknut, 1/2-20 nylon insert
8	3120-050S-Y	Washer, 1/2" hardened flat SAE

300-0145 - Upper Control Arms, Double-Adjustable

Qty	Part Number	Description
2	3818-09.00	g-Link control arm, double-adjustable, 9" long
90300-0145 - Hardware Bag		
4	3100-050F2.75Y	Bolt, 1/2-20 x 2-3/4" hex head Grade 8
4	3101-050-20C	Locknut, 1/2-20 nylon insert
8	3120-050S-Y	Washer, 1/2" hardened flat SAE

Weld Fixture for Upper-Arm Axle Housing Mounts (OPTION)

Qty	Part Number	Description
1	6732	Weld fixture for upper control arm axle mounts

AXLE HOUSING MOUNT SETS

(You will receive one of the four component groups listed unless FAB9 ordered)

For Sliding-Link or Omitted Anti-Roll Bar (OPTIONS)

(You will receive one of the two component groups listed unless FAB9 ordered)

300-0107 - For OEM Housing (Bolt-On Lower, Weld-On Upper)

Qty	Part Number	Description
1	230229	Upper axle bracket, driver side (weld-on)
1	230230	Upper axle bracket, passenger side (weld-on)
1	5336	Lower axle bracket with endlink mount, driver side (bolt-on)
1	5337	Lower axle bracket with endlink mount, passenger side (bolt-on)
90300-0107 - Hardware Bag		
8	3120-050S-Y	Washer, 1/2" hardened flat SAE
8	3131-050-20Y	Locknut, 1/2-20 nylon insert, Grade 8
4	3147-300.50-500	U-bolt, round 1/2-20 x 5" long x 3" ID

For Bare Housing (Weld-On Lower and Upper)

Qty	Part Number	Description
1	230229	Upper axle bracket, driver side (weld-on)
1	230230	Upper axle bracket, passenger side (weld-on)
1	5341	Lower axle bracket with endlink mount, driver side (weld-on)
1	5342	Lower axle bracket with endlink mount, passenger side (weld-on)

For Splined-End Anti-Roll Bar (OPTIONS)

(You will receive one of the two component groups listed unless FAB9 ordered)

300-0108 - For OEM Housing (Bolt-On Lower, Weld-On Upper)

Qty	Part Number	Description
1	230229	Upper axle bracket, driver side (weld-on)
1	230230	Upper axle bracket, passenger side (weld-on)
1	5338	Lower axle bracket with anti-roll bar mount, driver side (bolt-on)
1	5339	Lower axle bracket with anti-roll bar mount, passenger side (bolt-on)
90300-0108 - Hardware Bag		
8	3120-050S-Y	Washer, 1/2" hardened flat SAE
8	3131-050-20Y	Locknut, 1/2-20 nylon insert, Grade 8
4	3147-300.50-525	U-bolt, round 1/2-20 x 5" long x 3" ID

For Bare Housing (Weld-On Lower and Upper)

Qty	Part Number	Description
1	230229	Upper axle bracket, driver side (weld-on)
1	230230	Upper axle bracket, passenger side (weld-on)
1	5343	Lower axle bracket with anti-roll bar mount, driver side (weld-on)
1	5344	Lower axle bracket with anti-roll bar mount, passenger side (weld-on)

This suspension system replaces the majority of components in your existing rear suspension. It is necessary to remove all of the existing components to prepare for installation. **Cutting and welding is required.**

INSTRUCTIONS

A portion of the following installation photos were shot using a 1964-66 Mustang.

1. Before starting, measure the height of the rear wheel well opening from the ground on the driver and passenger sides. Record these dimensions.

This measurement will be used as a reference to adjust the height of the lower shock mount and verify that the ride height is set correctly.

2. Measure from the center of the axle to the fender lip. Record these measurements.

It may be easier to accurately measure from the center of the axle to the ground. This measurement can be subtracted from the previous fender-lip to ground measurement to calculate the needed dimension.

This information provides a reference point to correctly position rearend housing once the vehicle is off the ground and wheels are removed. Usually the vehicle ride height is kept at stock or slightly lower. Depending upon the choice of rear wheels and tires, the axle height may be modified.

3. Raise vehicle to a safe and comfortable working height. Use jack stands or a two-post lift to support the vehicle with suspension hanging freely. Make sure it is level front to rear and right to left.
4. Remove any portions of exhaust system that may interfere with installation. Mufflers in the stock location can remain in place. Unbolt or cut any exhaust tubing that is routed over the rear end housing.
5. Disconnect the driveshaft and brake lines from the rearend housing. Brake and fuel lines can remain on vehicle but will need to be secured along the body to prevent damage during installation.
6. Place a floor jack underneath the rearend center section to support its weight as the rear suspension is removed as an assembly.
7. Unbolt the front leaf-spring eyes and rear spring shackles from the vehicle, and remove the rear suspension.



Chassis Inspection

8. With the leaf springs out of the way, inspect the sheet metal for signs of fatigue. Clean the area to remove any grease or dirt so the metal and welds are clearly visible. Look for cracks along the welds or tearing of the mounts in any way. If there is any damage present, repairs will have to be made before proceeding.

9. Higher Performance Potential

We strongly recommend that the level of chassis prep be appropriate to your performance goals. Vehicles equipped with wide street tires (mini-tubbed, flares), drag-radials, or racing slicks must stitch-weld or fully-weld the factory seams in critical strength areas. The combination of high-horsepower and available traction will damage the frame rails if necessary precautions are not taken.

- Prior to welding, use a hammer to flatten the factory seams.
- Grind down any welds that interfere with proper fitment of the suspension chassis mounts.
- Welds that will be covered by the chassis mounts must be painted prior to installing the mounts.

IMPORTANT: The rear seat must be removed before welding. The lower seam weld is along the interior panel and will ignite any material that has not been cleared from this area.

10. Allow the welds to cool, then paint to protect the metal from rust.

Lower Arm Mounts

11. The front leaf spring hangers and the section that drops down will be removed and upgraded to a stronger mounting bracket. Any spot welds attaching the factory spring hanger must be drilled or ground out. A cutoff wheel should be used to removed the floor section so that the new bracket seats flush and square.

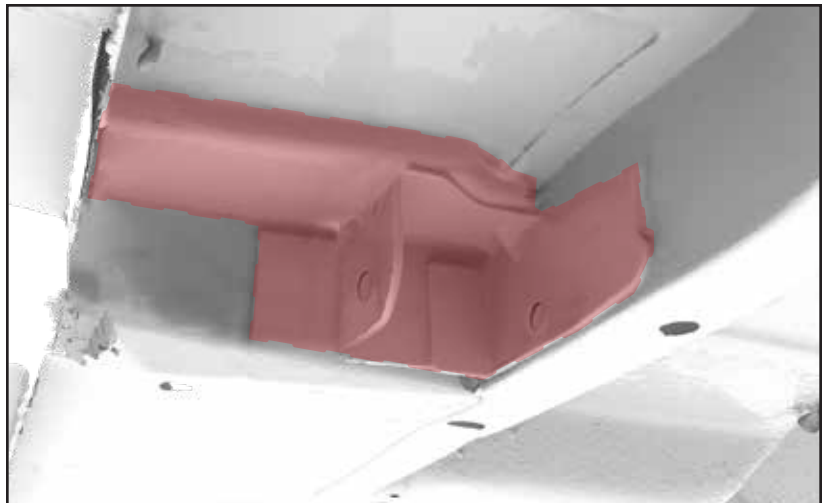

12. The new bracket is positioned using the lower control arm bolt and fills the area between the frame rail, floor and rocker structure.

13. Grind all weld areas and tack weld to hold securely.

14. Plug weld the four holes at the top and stitch weld around the perimeter of the mount.

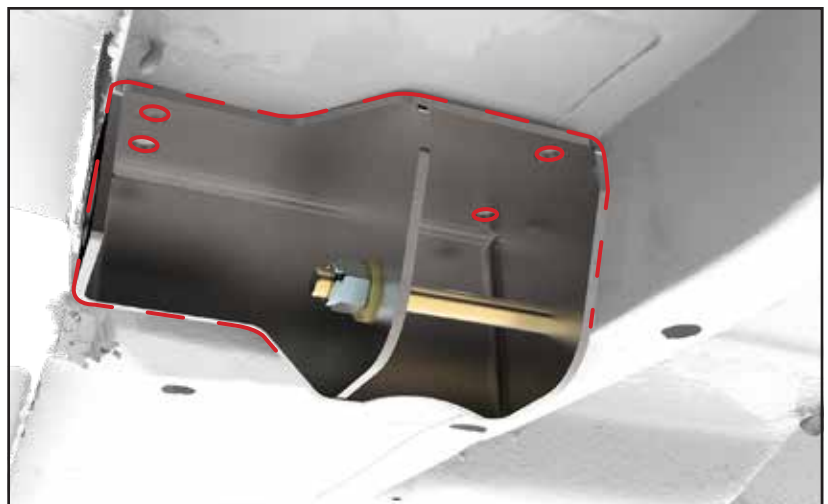

Upper Control Arm Mounts

15. The upper arm mounts seat into the corner of the frame rail and forward side of the stock shock mount.
16. Grind all weld areas and tack weld to hold securely.
17. The tab that covers the bottom of the frame rail may be stitch welded.

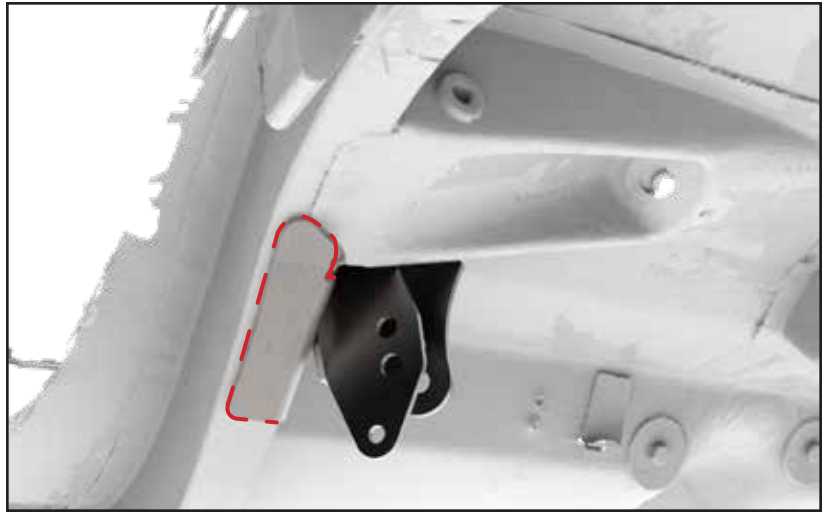

18. We recommend fully welding the perimeter of the mount. This can be done in a series of stitch welds to fully close the bead.

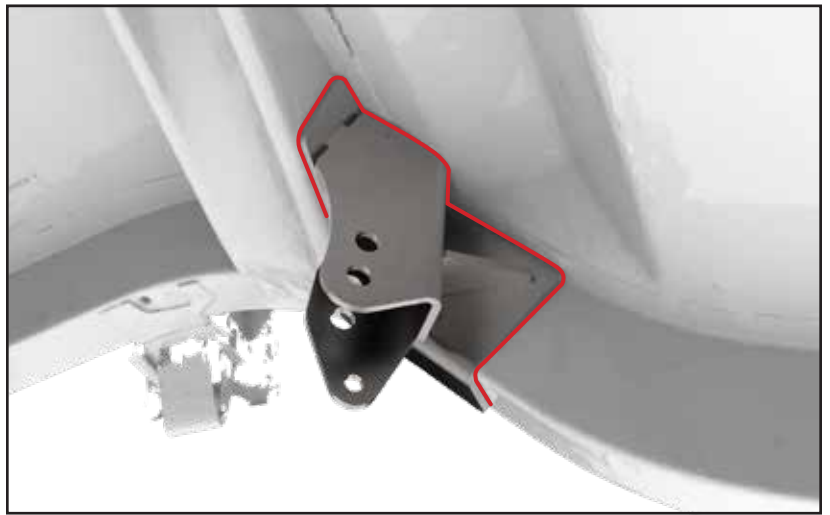

Shock Crossmember Mounts

19. Loosely bolt the driver and passenger frame brackets to the crossmember. The bracket holes are slotted to allow proper fit with variances at the frame rails.



20. Position the shock crossmember assembly against the vehicle, seating the frame brackets against the back corner of the factory shock mount.



21. Clamp the brackets against the frame rails to hold the crossmember in place.
22. Tighten the assembly hardware.
23. Use a marker to trace the outline of the frame brackets. This marked area will be ground to bare metal for welding the bracket to the frame rail.
24. Scribe the bracket's oval holes onto the surface of each frame rail.



25. Once both brackets are clearly marked, unclamp the crossmember assembly and remove from vehicle.
26. Center punch and drill a "starting hole" through the frame rail at each scribed oval, using a 3/8"-diameter bit.



27. Use a die grinder or file to enlarge the holes to the scribed outline.



28. Use a scotch-brite disc to expose bare metal along the marked weld line on the frame rail. DO NOT grind into the frame rail. Paint and debris only need to be removed in order to prep a good weld area.



29. Clamp the crossmember into the car and align the frame brackets with slotted holes in frame rail.

30. Install one 3/8" flat washer and locknut onto one end of each square-corner U-bolt to prevent losing the U-bolt inside the frame rail.

31. Insert the other end of the U-bolt into the hole in the frame bracket, and then out through the second hole.



32. Place a 3/8" washer over the stud and secure with a locknut.
33. Once both bolts are in place, evenly tighten the locknuts to 30 lb-ft.
34. Tack weld each bracket to the frame rail.
35. Stitch weld 1" long beads, 1" apart around the complete outside edge of each bracket.

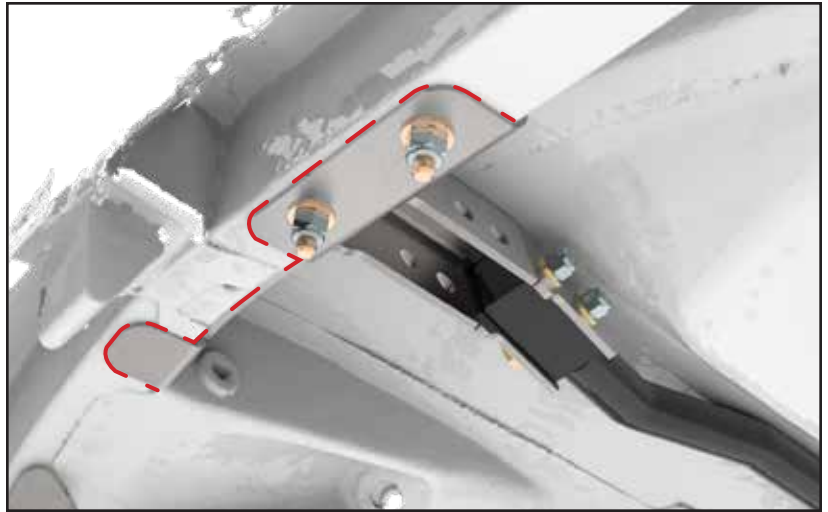

36. Weld as far up the ends of the brackets as possible, as well as the top of the bracket where it contacts the double layer in the unibody frame rail.

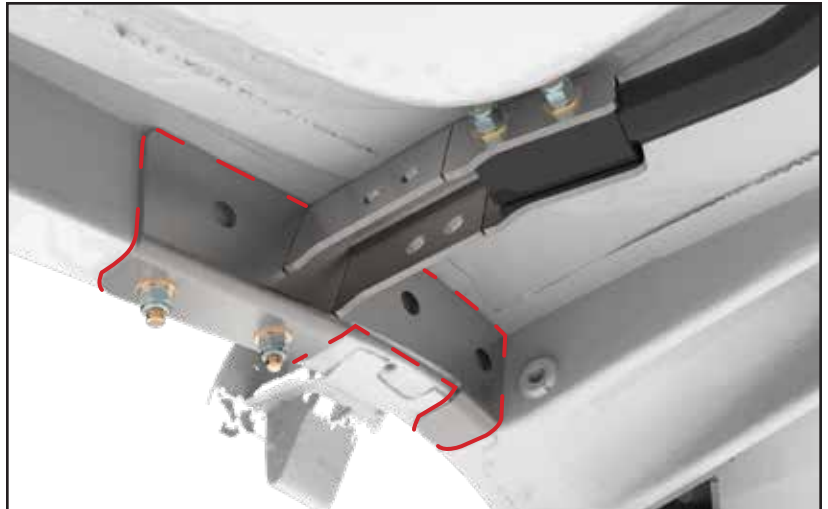

37. Allow the welds to cool, then paint all areas to protect the metal from rust.



Welding Upper Control Arm Mounts

38. All fluid must be drained and residue removed from housing to reduce risk of fire during welding.
39. All components must be removed including brakes, axles, and third-member.
40. Weld fixture bolts directly to 9" housings and can be clamped to the face of 8" housings. If clamping the fixture, measure from the housing ends to the fixture to be sure it is centered. Refer to installation guide for specific instructions on using the weld fixture.
41. Position the lower axle brackets onto the rearend-housing spring plates. The powder coating on the alignment pin may have to be removed for the bracket to fully seat.
42. Place the 1/2" U-bolts over the axle tube and through the holes in the axle bracket. Secure with flat washers and locknuts. Tighten evenly to 60 lb-ft.

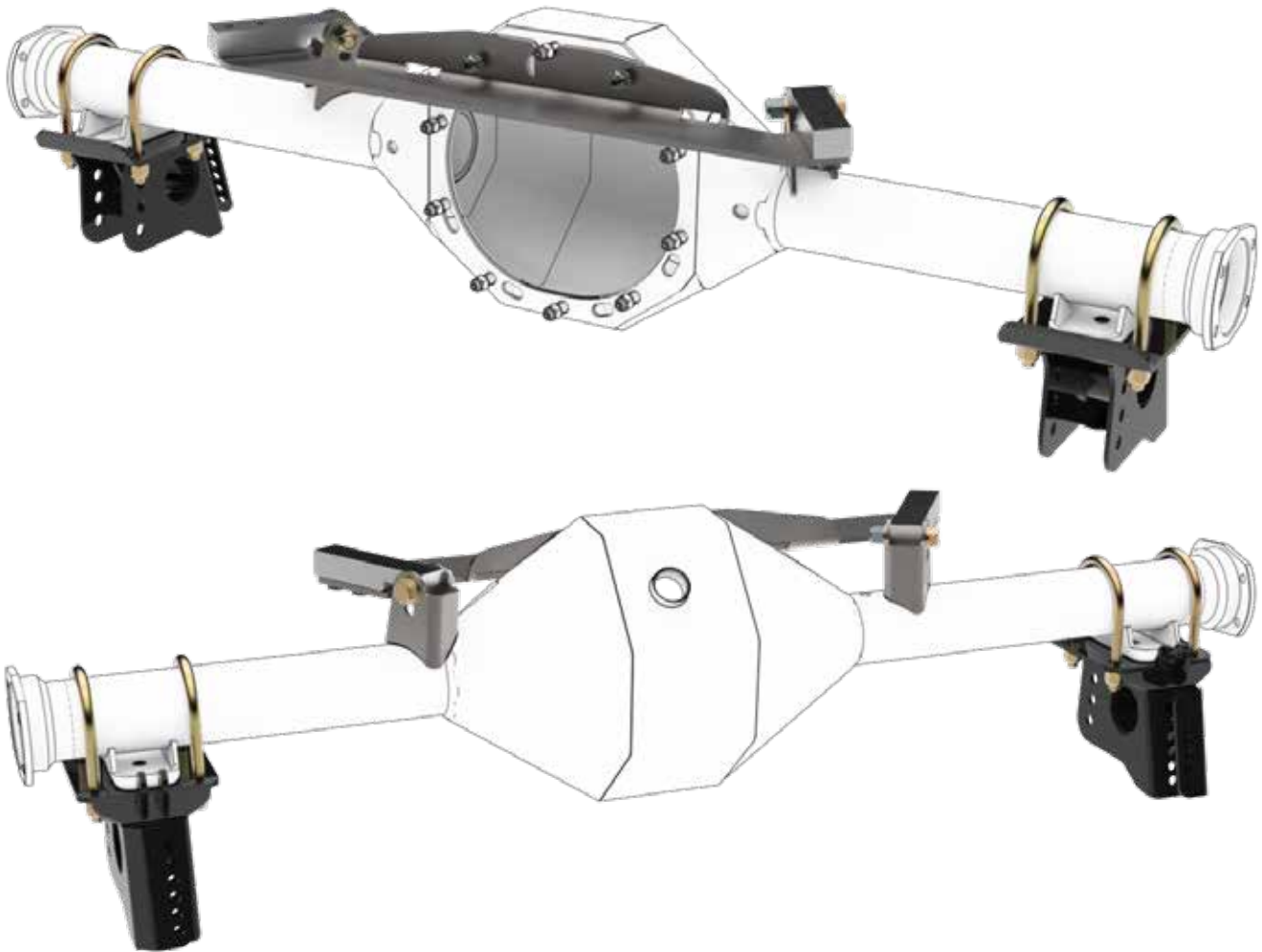

Chassisworks FAB9™ Housings

Bolt-in FAB9™ rearend housings are available pre-assembled with welded upper and lower control arm brackets. Housings accept Ford 9" third-members and axles. Installation of control arms and anti-roll bars is identical to factory housing installations.



43. Position the rearend housing under the car on jack stands.



44. Adjust the upper suspension links to 9-1/2", measured from the center of each mounting hole.

Poly bushing arm shown in image.



45. Attach the adjustable end of the upper links to the chassis mount with 1/2" bolts, flat washers and locknuts. Grease zerk fittings must point downward. Do not fully tighten at this time.

46. Bolt opposite end of each upper link to the rear end housing. Grease zerk fittings must point upward. Do not fully tighten at this time.



47. Install the lower suspension links at the factory front leaf spring mount using 1/2" diameter bolts, flat washers and locknuts. Grease zerk fittings must point downward. Do not fully tighten at this time.



48. Attach the lower suspension links to the axle brackets with 1/2" bolts, flat washers and locknuts. Use the second hole from the bottom on the axle brackets for initial installation. Torque to 65 lb-ft.



49. Raise and support the rearend housing to the ride-height position that was measured earlier. Measure from the center of the axle to the top of the fender.

50. Slide the billet shock mount into the lower link bracket on the housing. Leave one hole a blank at the bottom and secure the shock mount with the 3/8" bolts, aircraft washers and locknuts supplied. Tighten the bolts to 35 lb-ft.



51. Raise the rearend housing so that the distance from the billet shock mount hole to the center upper-shock-mount hole measures 14". This is the baseline ride-height position

52. Check the axle center to fender lip opening from Step 2. Adjust the billet lower shock mount position to correctly position the axle housing at the original ride height or a different ride height if desired.

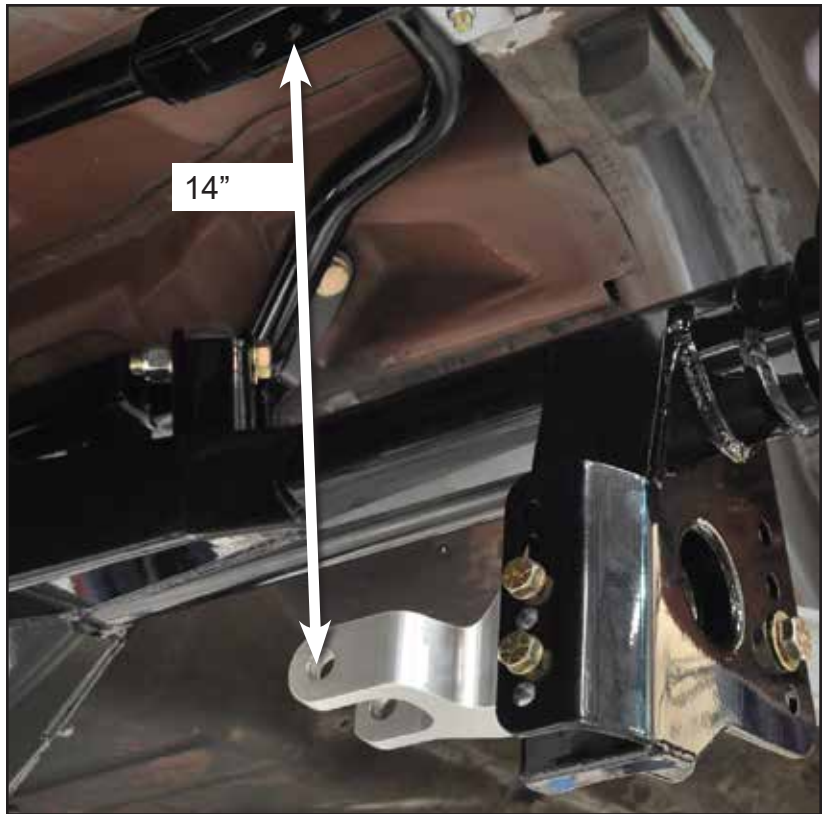

53. Beginning at the upper shock mount, install the 1/2" bolts, flat washers and locknuts from the front to rear.



54. Moving on to the lower shock mount, install the 1/2" bolts, flat washers and locknuts from the rear to front.



The following steps were photographed using coil-over shocks. The procedure is identical.

55. Adjust both shocks to their softest setting.
56. Lightly inflate each air-spring to allow the bag to operate normally, but still be easily compressed.
57. Using a jack, cycle rear suspension through its full range of vertical travel and body roll to check for binding and potential clearance issues. *You MUST have at least 3/4" clearance around the air spring when inflated.*
58. Once clearance has been verified, torque to 50 lb-ft.

NOTE: When moving lower shock mounts or suspension link mounting locations the suspension must be checked for binding and adequate clearance throughout its full range of vertical travel and body roll.

59. Reassemble the rearend components and the installation is complete. The upper suspension links can now be used to first center the rearend in relation to the chassis, and then to adjust pinion angle. Lengthening one upper link and shortening the other upper link will move the housing toward the shortened link. Pinion angle is adjusted by shortening or lengthening both links equally. Additional information regarding pinion angle can be found on page 22. Link ends will need to be unbolted from axle brackets to adjust length.

NOTE: Carefully read the Pinion Angle section at the end of this installation guide before determining the correct pinion angle. Once the adjustments are made tighten the four link bolts to 65 lb-ft.

Refer to VariShock air-spring installation guide for specific instructions regarding pressure settings and valve adjustment.



Full Compression



Full Extension



Full Roll

Mounting Options and Final Adjustments

Lower Suspension Link

Mounting Position: The lower link has three (factory housing) or four (FAB9™ housing) mounting positions at the axle bracket. Ideally, to minimize suspension steering effects (roll steer), the link should be set as close to horizontal as possible with the suspension at ride height. Lowering the rear position from horizontal will also increase available traction, but also increases roll oversteer.

Length (pivot-ball link only): Correct adjusted length is 21.00", measured at the center of the bolt holes. Due to chassis variances it may be necessary to adjust the lower suspension link lengths to position the rear end housing square to the chassis.

Upper Suspension Link

Mounting Position: The upper link has two mounting positions at the frame bracket and axle bracket. The starting installation position provides the largest anti-squat percentage and provides more immediate traction to the rear tires (less chassis movement). Lowering the front position and/or raising the rear position provides less anti-squat and a more gradual transfer of weight to the rear tires (more chassis movement).

Length: Correct adjusted length is 9.50", measured at the center of the bolt holes. Due to chassis variances it may be necessary to center the housing in relation to the chassis by adjusting the upper suspension link lengths.

Shock Absorber

Lower Mounting Position: The lower shock mount can be moved to one of four positions to alter ride height in 5/8" increments.

Upper Mounting Position: The upper shock mount can be moved to one of three positions along the upper crossmember. Ride height is altered in 1/4" increments at each position with approximately a 5% change in shock/spring stiffness and ride quality. Outermost hole = highest/stiffest; Innermost hole = lowest/softest.

Spring Preload: Refer to VariShock coil-over installation guide (899-031-200 or 899-031-220) for detailed information regarding spring preload and correct balance of travel at ride height.

Under no circumstance should the lower spring seat be used to adjust the shock length at ride-height to less than 13" or more than 14". Damage to the shock absorbers will occur, and you will be charged to repair them.

Maintenance

Suspension Link Lubrication

Each suspension pivot assembly can be lubricated using a standard grease gun. Pivot-ball links without a grease zerk fitting can be lubricated by removing the locking set screw and temporarily installing a zerk fitting.

Pivot-Ball Preload

The retaining ring can be tightened to remove any free-play that develops in the pivot-ball mechanism. Remove the locking set screw and turn the retaining ring clockwise, using a common spanner wrench, to the next set screw position.

Bushing Wear

The urethane bushing should be inspected once a year for wear and replaced if there is excessive movement in the links. On high horsepower cars this should be checked more often.

Pinion Angle

Understanding Pinion Angle

The often misunderstood pinion angle is simply the angle formed by the centerlines of the driveshaft and rear differential pinion gear where they meet at the rear u-joint. When the pinion angle is set correctly, it is the same angle, but in the opposite direction as the angle formed by the engine-transmission centerline and the driveshaft at the front u-joint (see illustration below). The pinion angle is usually adjusted to match the engine angle as it is easier to change. Contrary to popular opinion, pinion angle is not a tuning aid. Correctly set, it will balance the driveshaft u-joints minimizing vibration and power loss.

Measuring the Drivetrain Angles

A digital protractor or smart level is the best tool to measure the required angles. Engine centerline measurement can be taken from the vertical surface of the transmission tailshaft, the oil pan rail, or the front face of the harmonic balancer. Most production vehicle drive-train angles will run slightly downhill towards the rear bumper. A typical measurement may be 2 to 3 degrees. Driveshaft centerline angles can be measured directly on the shaft tube. Pinion gear centerline angles can be measured on the universal joint yoke or axle housing flange. It is important to be careful how you position the measuring tool so all the angles have the same reference plane. Remember the measurements must be taken with the rear suspension collapsed to the correct ride height.

Adjusting the Third Member Pinion Angle

As an example, a two-degree downhill drivetrain angle would require the third member to be set at two degrees with the snout slightly raised. Pinion angle is set by equally adjusting the upper control arm lengths. Lengthening the arms raises the pinion snout. Upper arm must be unbolted from the axle tabs and jam nut loosened for adjustment. Be sure to tighten the jam nuts and mounting hardware to the torque value specified in this installation guide.

Note: High traction vehicles operated for extended periods at full throttle, such as drag or road racing, may need to compensate for flex in the suspension system by setting the pinion angle an additional 1 to 2 degrees down to avoid drivetrain vibration.

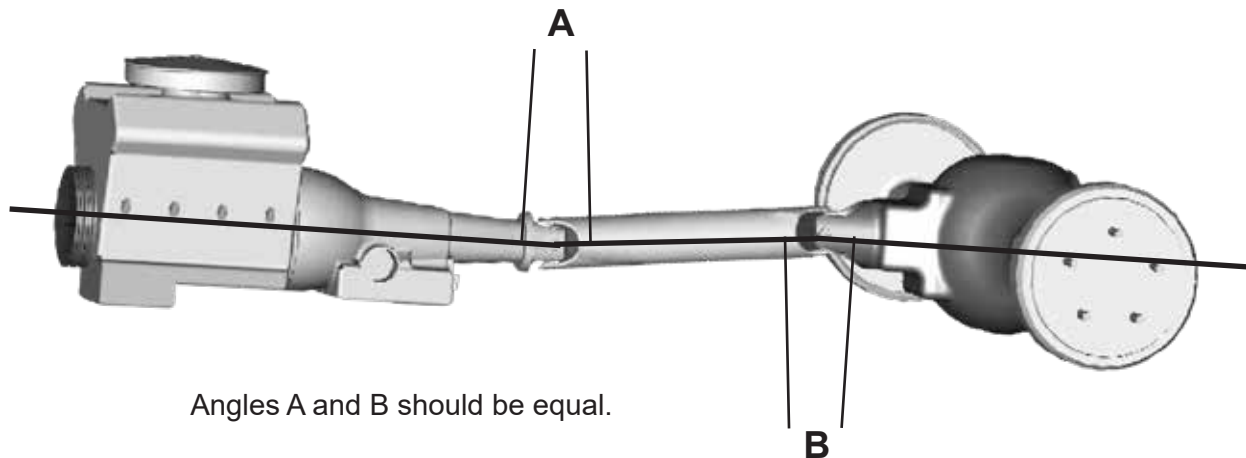

NOTES:

WARRANTY NOTICE:

There are NO WARRANTIES, either expressed or implied. Neither the seller nor manufacturer will be liable for any loss, damage or injury, direct or indirect, arising from the use or inability to determine the appropriate use of any products. Before any attempt at installation, all drawings and/or instruction sheets should be completely reviewed to determine the suitability of the product for its intended use. In this connection, the user assumes all responsibility and risk. We reserve the right to change specification without notice. Further, Chris Alston's Chassisworks, Inc., makes **NO GUARANTEE** in reference to any specific class legality of any component. **ALL PRODUCTS ARE INTENDED FOR RACING AND OFF-ROAD USE AND MAY NOT BE LEGALLY USED ON THE HIGHWAY.** The products offered for sale are true race-car components and, in all cases, require some fabrication skill. **NO PRODUCT OR SERVICE IS DESIGNED OR INTENDED TO PREVENT INJURY OR DEATH.**

Chris Alston's Chassisworks
8661 Younger Creek Drive
Sacramento, CA 95828
Phone: 916-388-0288
Technical Support: tcptech@cachassisworks.com

